



Technical Data Sheet

BC-TAB-C-4,5mm H17 Circular Spacer Tab

COMPONENTS

The BC-TAB-C-4,5mm H17 is composed of 1 piece.

CHARACTERISTICS

Weight: 0,002 kg

Height: 17mm

MATERIAL

POM 100%

Designed and manufactured in Europe.

Resistant to weathering and a wide range of chemicals.

Temperature range: -30 °C to +80 °C

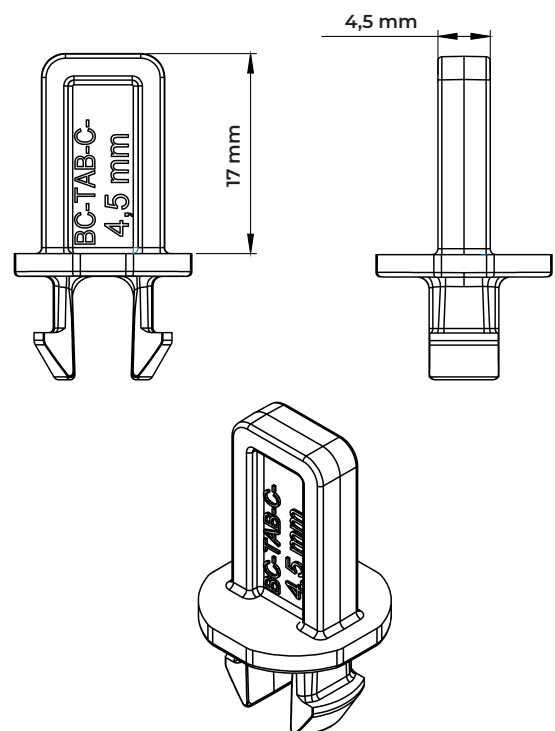

PACKAGING

Pieces per carton: 2400 pcs

Carton weight: 3,94 kg

Carton dimension: 390 x 280 x 145 mm

Cartons per pallet: 130 pcs

Pieces per pallet: 312 000 pcs

Pallet dimensions: 100 x 120 x 220 cm

APPLICATIONS

The circular spacer tabs, BC-TAB-C, are fixed by pressure on the BUZON® pedestals of the BC range. The spacer tabs regulate the spacing between the pavers, ensure alignment and free water drainage. These are circular and adapt perfectly to all forms of paver and allow the installation of terraces with geometric patterns.

The accessory is available for applications with various outdoor finishes, such as granite stone pavers, wood/composite tiles, ceramic tiles and fibreglass or metal grating panels.

SAFETY INSTRUCTIONS

Buzon pedestals and accessories are designed to support external raised floors for pedestrian traffic only and are not designed to support or be subjected to moving and/or vibrating machinery & equipment, including maintenance, cleaning vehicles, automobiles and other similar equipment.

