



Technical Data Sheet

U-E20-FLEX - Damper 2 mm for U-TOP-FLEX

COMPONENTS

The **U-E20-FLEX** is composed of 1 piece.

CHARACTERISTICS

Diameter: \varnothing 175 mm

Thickness: 2 mm

MATERIAL

Material: **SBR**

Hardness Shore A DIN 53505: **60-80 SHA**

Color: **Black**

Density: **1.55 g/cm³**

Temperature range: **-30°C to +/- 70 °C**

Tensile Strength DIN 53504: **3 Mpa**

Elongation at break DIN 53504: **250%**

Resistant to weathering, sea salts, algae and a wide range of chemicals.

PACKAGING

Pieces per carton: **120 pcs**

Carton weight: **6.7 kg**

Cartons per pallet: **48 pcs**

Pieces per pallet: **5760 pcs**

Pallet dimensions: **80 x 120 x 110 cm**

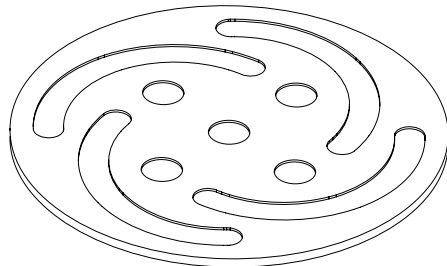
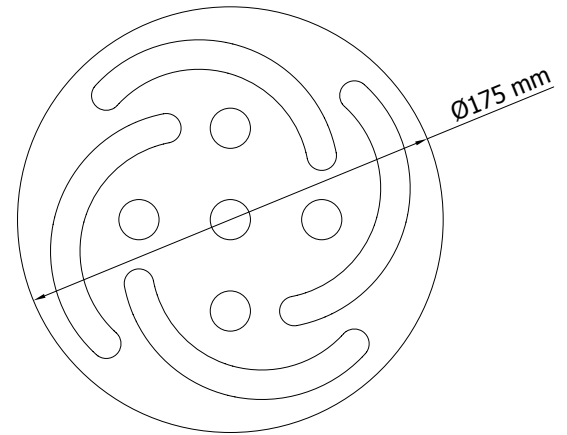

2 mm

APPLICATIONS

The **U-E20-FLEX** is a 2 mm damper. Placed on the **U-TOP-FLEX** support, it stabilises the paver, provides additional acoustic comfort, and compensates for variations in paver thickness.

SAFETY INSTRUCTIONS

Buzon pedestals and accessories are designed to support external raised floors for pedestrian traffic only and are not designed to support or be subjected to moving and/or vibrating machinery & equipment, including maintenance, cleaning vehicles, automobiles and other similar equipment.